

CONTENTS	PAGE
1. PRODUCT INTRODUCTION.....	1
1-1.Description.....	1
1-2.Feature.....	2
2. TECHNICAL SPECIFICATION.....	4
3. PRECAUTIONS BEFORE OPERATION.....	7
3-1.Unpacking the instrument.....	7
3-2.Checking the Line Voltage.....	7
3-3.Environment.....	8
3-4.Equipment Installation and Operation.....	8
3-5.CRT Intensity.....	8
3-6.Withstanding Voltage of Input Terminals.....	8
4. PANEL INTRODUCTION.....	9
4-1.Front Panel.....	11
4-2.Rear Panel.....	30
5. OPERATION METHOD.....	32
5-1.Readout Display.....	32
5-2.Connecting Input Signals.....	34
5-3.Adjustment and Checks.....	35
5-4.Function Check.....	37
5-5.Basic Operation.....	39
5-6.Measurement Application.....	47
6. MAINTENANCE.....	51
6-1.Fuse Replacement.....	51
6-2.Line Voltage.....	51
6-3.Cleaning.....	52
7. BLOCK DIAGRAM.....	53

SAFETY TERMS AND SYMBOLS

These terms may appear in this manual or on the product:



WARNING. Warning statements identify condition or practices that could result in injury or loss of life.



CAUTION. Caution statements identify conditions or practices that could result in damage to this product or other property.

The following symbols may appear in this manual or on the product:



DANGER
High Voltage



ATTENTION
refer to Manual



Protective
Conductor

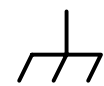

Earth(ground)
Terminal

FOR UNITED KINGDOM ONLY

NOTE: This lead/appliance must only be wired by competent persons

WARNING: THIS APPLIANCE MUST BE EARTHED

IMPORTANT: The wires in this lead are coloured in accordance with the following code:

Green/ Yellow:	Earth
Blue:	Neutral
Brown:	Live (Phase)

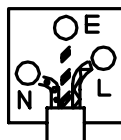

As the colours of the wires in main leads may not correspond with the colours marking identified in your plug/appliance, proceed as follows:

The wire which is coloured Green & Yellow must be connected to the

Earth terminal marked with the letter E or by the earth symbol  or coloured Green or Green & Yellow.

The wire which is coloured Blue must be connected to the terminal which is marked with the letter N or coloured Blue or Black.

The wire which is coloured Brown must be connected to the terminal marked with the letter L or P or coloured Brown or Red.

If in doubt, consult the instructions provided with the equipment or contact the supplier.

This cable/appliance should be protected by a suitably rated and approved HBC mains fuse: refer to the rating information on the equipment and/or user instructions for details. As a guide, cable of 0.75mm² should be protected by a 3A or 5A fuse. Larger conductors would normally require 13A types, depending on the connection method used.

Any moulded mains connector that requires removal /replacement must be destroyed by removal of any fuse & fuse carrier and disposed of immediately, as a plug with bared wires is hazardous if engaged in live socket. Any re-wiring must be carried out in accordance with the information detailed on this label.

EC Declaration of Conformity

We

GOOD WILL INSTRUMENT CO., LTD.

(1) No. 95-11, Pao-Chung Rd., Hsin-Tien City, Taipei Hsien, Taiwan

(2) Plot 522, Lorong Perusahaan Baru 3, Prai Industrial Estate, 13600 Prai, Penang, Malaysia
declares that the below mentioned product

GOS-6112

is herewith confirmed to comply with the requirements set out in the Council Directive on the Approximation of the Law of Member States relating to Electromagnetic Compatibility (89/366/EEC, 92/31/EEC, 93/68/EEC) and Low Voltage Equipment Directive (73/23/EEC).

For the evaluation regarding the Electromagnetic Compatibility and Low Voltage Equipment Directive, the following standards were applied:

EN 61326-1: Electrical equipment for measurement, control and laboratory use — EMC requirements (1997+A1: 1998)

Conducted and Radiated Emissions EN 55011 class B: 1991 EN 55022 class B: 1994	Electrostatic Discharge EN 61000-4-2: 1994
Current Harmonic EN 61000-3-2: 1995	Radiated Immunity ENV 50140: 1993
Voltage Fluctuation EN 61000-3-3: 1995	Electrical Fast Transients EN 61000-4-4: 1995
-----	Surge Immunity EN 61000-4-5: 1995
-----	Conducted Susceptibility EN 61000-4-6: 1996
-----	Power Frequency Magnetic field EN 61000-4-8: 1993
-----	Voltage Dips/ Interrupts EN 61000-4-11: 1994

Low Voltage Equipment Directive 73/23/EEC & amended by 93/68/EEC

Safety Requirements
EN 61010-1: 1990+A1: 1992+A2: 1995
IEC 61010-1: 1990+A1: 1992+A2: 1995

1.PRODUCT INTRODUCTION

1-1. Description

The GOS-6112 is a 100MHz, two-channel, dual-sweep, portable oscilloscope for general purpose use. A microprocessor-based operating system controls most of the functions of the instrument, including cursor readout and digitized panel setting. On-screen alphanumeric readout and cursor function for voltage, time, frequency and phase measurement provide extraordinary operational convenience.

The vertical deflection system has two input channels. Each channel has 11 basic deflection factors from 2mV to 5V per division. The horizontal deflection system provides single, dual or delayed sweeps from 0.5s to 50ns per division (delayed sweep, 50ms to 50ns per division). The trigger system provides stable triggering over the full bandwidth of the vertical deflection system.

1-2.Features

Additionally, the oscilloscope offers several other features:

1) High intensity and internal graticule CRT

The oscilloscope employs a high intensity 6-inch rectangular type cathode-ray tube with red internal graticule. It displays clear readable traces even at high sweep speeds. Internal graticule lines eliminate parallax-viewing error between the trace and the graticule line.

2) Temperature compensation

The oscilloscope uses a temperature compensation circuit to reduce the drift of base line and DC balance.

3) 20MHz bandwidth limit

When it is hard to observe or trigger a signal because a high-frequency component is superimposed on the signal, use the 20MHz BWL function to reduce the bandwidth of the vertical deflection system and trigger system to 20MHz.

4) TV triggering

Exclusive TV sync separator circuit technology provides stable TV signal measurements on fields, frames and lines.

5) Z-axis intensity modulation

For applying a blanking signal from an external source. The trace displayed on the screen may be intensity-modulated where pulse signal or time-scale marks are required.

6) Trigger signal output

The signal selected by the TRIGGER SOURCE is available. This output may be used to connect to a frequency counter or other instrument.

7) Panel setups lock

To avoid unintentional touch of the setting, the feature is extremely useful for long term and repetitive measurements that used to be performed under the same test condition of the oscilloscope setting.

8) LED indicator and buzzer alarm

The LED's located in the front panel assist operation and indicated additional information. Incorrect operation and the electrical end position of control knobs are indicated by a warning beep.

9) SMD manufacturing technology

The instrument is built by using the most advanced SMD technology so as to reduce the number of internal wiring and shorten the foil route on the pc board. This will also greatly increase the high frequency performance and the reliability of the product.

2. TECHNICAL SPECIFICATIONS

VERTICAL DEFLECTION SYSTEM	Sensitivity	2mV~5V/DIV, 11 step in 1-2-5 sequence			
	Sensitivity Accuracy	±3% (5 DIV at the center display)			
	Vernier Vertical Sensitivity	Continuously variable to 1/2.5 or less than panel-indicated value			
	Frequency Bandwidth(-3dB)	DC ~ 100MHz (2mV/DIV:DC ~ 20MHz)			
	Rise Time	3.5ns (2mV/DIV:17.5ns)			
	Signal Delay	Leading edge can be monitored			
	Maximum Input Voltage	400V (DC+AC) at 1kHz or less			
	Input Coupling	AC, DC, GND			
	Input Impedance	1MΩ±2% // 25pF approx.			
	Vertical Modes	CH1, CH2, DUAL(CHOP/ALT), ADD(DIFF mode can be established when the CH2 is in the INV mode)			
	CHOP Repetition Frequency	Approx. 250kHz.			
	Polarity (INV)	CH2 only			
	Bandwidth Limited	20MHz			
	Common-mode Rejection Ration	50:1 or better at 50kHz			
Dynamic Range	8 div at 60MHz, 5 div at 100MHz.				
TRIGGER SYSTEM	Trigger Modes	AUTO, NORM, TV			
	Trigger Source	CH1, CH2, LINE, EXT			
	Trigger Coupling	AC, DC, HFR, LFR			
	Trigger Slope	+/- polarity or TV sync polarity			
	Trigger Sensitivity	Mode	Frequency	INT	EXT
			10Hz~20MHz	0.35DIV	50mVpp
		NORM	20MHz~100MHz	1.5DIV	150mVpp
			DC~20MHz	0.35DIV	50mVpp
	TV	Sync signal	1DIV	200mVpp	
	Trigger Level Range	INT : ± 4 DIV or more EXT : ± 0.4 V or more			
TV Sync	TV-V, TV-H				
Max. External Input Voltage	400V (DC + AC peak) at 1kHz				
External Input Impedance	1MΩ± 5% // 25pF approx.				

HORIZONTAL DEFLECTION SYSTEM	Horizontal Modes	MAIN(A), ALT, DELAY(B)
	A (main) Sweep Time	50nS~0.5S/DIV, continuously variable (UNCAL)
	B (delay) Sweep Time	50nS~50mS/DIV
	Accuracy	± 3% (± 5% at × 10 MAG)
	Sweep Magnification	× 10 (maximum sweep time 5nS/DIV)
	Hold Off time	Variable
	Delay Time	1uS~5S
X-Y OPERATION	Delay Jitter	1/20000 or less
	Alternate Separation	Variable
	Sensitivity Accuracy	X-axis, Y-axis selectable X-axis: CH1, CH2 → 2mV~5V/DIV ± 3% EXT → 0.1V/DIV ± 5% Y-axis: CH1, CH2 → 2mV~5V/DIV ± 3%
CURT	X-axis Bandwidth	DC~500kHz (-3dB)
	Phase Error	3° or less at DC~50kHz
	Cursor Measurement Function	Δ V, Δ V%, Δ VdB, Δ T, 1/Δ T, Δ T%, Δ θ.
	Cursor Resolution	1/100 DIV
CURT READOUT FUNCTION	Effective Cursor Range	Vertical: ± 3 DIV; horizontal: ± 4 DIV
	Panel setting	Vertical: V/DIV (CH1, CH2), UNCAL, ADD, INV, P10, AC/DC/GND. Horizontal: S/DIV (MTB, DTB), UNCAL × 10MAG, Delay time, Hold-off. Trigger: Source, Coupling, Slope, Level, TV-V/TV-H. Others: X-Y, LOCK.
	Type	6-inch rectangular type with internal graticule 0%, 10%, 90% and 100% markers. 8 × 10 DIV (1 DIV = 1 cm)
	Phosphor	P31
Z-AXIS INPUT	Accelerating Potential	12kV approx.
		External intensity modulation
	Coupling	DC
	Voltage	5V or more
	Maximum Input Voltage	30V (DC+AC peak) at 1kHz or less
Bandwidth	DC~5MHz	

TRIGGER SIGNAL OUTPUT	Voltage	25mV/DIV approx. in 50 Ω termination
	Frequency Response	DC~10MHz
	Output Impedance	50 Ω approx.
CALIBRATOR OUTPUT	Waveform	1kHz \pm 5%, square wave
	Voltage	2Vpp \pm 2%
	Impedance	2k Ω approx.
SPECIAL FUNCTION	Panel Setups Lock	Provided
LINE POWER REQUIREMENT	Voltage	AC 110V, 120V, 230V \pm 10% selectable
	Frequency	50Hz or 60Hz
	Power Consumption	Approx. 90VA, 70W(max.)
OPERATING ENVIRONMENT	Indoor use Altitude up to 2000 m Ambient temperature : To satisfy specifications : 10° to 35°C (50° to 95°F) Maximum operating ranges: 0° to 40°C (32 °to 104°F) Relative humidity:85% RH(max.) non condensing Installation Category II Pollution degree 2	
STORAGE TEMPERATURE & HUMIDITY	-10° to 70°C , 70%RH(maximum)	
MECHANICAL SPECIFICATION	Dimensions	310 W \times 150 H \times 455 D (mm)
	Weight	Approx. 9kgs (19.8 lbs)
ACCESSORIES	Power cord..... 1 Instruction manual..... 1 Probe (\times 1/ \times 10)..... 2	

3.PRECAUTIONS BEFORE OPERATION

3-1.Unpacking the Oscilloscope

The product has been fully inspected and tested before shipping from the factory. Upon receiving the instrument, please unpack and inspect it to check if there is any damages caused during transportation. If any sign of damage is found, notify the bearer and/or the dealer immediately.

3-2.Checking the Line Voltage

The oscilloscope can be applied any kind of line voltage shown in the table below. Before connecting the power plug to an AC line outlet, make sure the voltage selector of the rear panel is set to the correct position corresponding to the line voltage. It might be damaged the instrument if connected to the wrong AC line voltage.



WARNING. To avoid electrical shock the power cord protective grounding conductor must be connected to ground.

When line voltages are changed, replace the required fuses shown as below:

Line voltage	Range	Fuse	Line voltage	Range	Fuse
110V 120V	90-110V 108-132V	T 1A 250V	230V	195-250V	T 0.4A 250V



WARNING. To avoid personal injury, disconnect the power cord before removing the fuse holder.

3-3.Environment

The normal ambient temperature range of this instrument is from 0° to 40°C (32° to 104°F). To operate the instrument over this specific temperature range may cause damage to the circuits.

Do not use the instrument in a place where strong magnetic or electric field exists as it may disturb the measurement.

3-4.Equipment Installation, and Operation

Ensure there is proper ventilation for the vents in the oscilloscope case. If this equipment is used not according to the specification, the protection provided by the equipment may be impaired.

3-5.CRT Intensity

To prevent permanent damage to the CRT phosphor, do not make the CRT trace brighten excessively or leave the spot stay for an unreasonably long time.

3-6.Withstanding Voltages of Input Terminals

The withstanding voltages of the instrument input terminals and probe Input terminals are shown in the following table. Do not apply voltages higher than these limits.

Input terminal	Maximum input voltage
CH1, CH2, inputs	400V (DC + AC peak)
EXT TRIG input	400V (DC + AC peak)
Probe inputs	600V (DC + AC peak)
Z AXIS input	30V (DC + AC peak)



CAUTION. To avoid instrument damage, do not apply exceeding maximum input voltages of the frequency less than 1 kHz to the instrument.

4. PANEL INTRODUCTION

After the instrument is switched on, all the important settings are displayed in the readout. The LED's located on the front panel assist operation and indicate additional information. Incorrect operation and the electrical end positions of control knobs are indicated by a warning beep.

Except the Power pushbutton (POWER), the Focus control (FOCUS), the Scale Illumination control (ILLUM) and the Trace Rotation control, all other controls are electronically selected, and their functions and settings can therefore be stored.

The front panel is subdivided into six sections:

- Display controls
- Vertical controls
- Horizontal controls
- Trigger controls
- Measurement and SAVE/RECALL controls
- Input connectors

Front panel of GOS-6103

4-1.Front Panel

Display controls

The display controls adjust the on-screen appearance of the waveform and provide a probe compensation signal source.

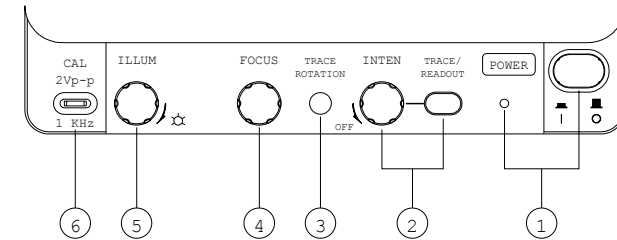

- (1). **POWER** – Pushbutton and symbols for ON(1) and OFF(0).

When switch on the oscilloscope to have all LEDs lighted and the software version will be displayed on the screen. After the Internal test is completed successfully, the normal operation mode is present. Then the last settings become activated and the LED indicates the ON condition.

- (2). **INTEN – TRACE/READOUT** – Control knob with associated pushbutton and readout display.

The control knob is used for adjusting the traces and readout intensity. Turning the knob clockwise to increase the intensity and turning it counterclockwise to decrease the intensity.

The TRACE/READOUT pushbutton is for selecting the intensity function and indicates the letter “TRACE INTEN” or “READOUT INTEN” in the readout. Press the pushbutton briefly for the following sequences:

“TRACE INTEN” — “READOUT INTEO” — “TRACE INTEN”

(3).TRACE ROTATION

The TRACE ROTATION is for aligning the horizontal trace in parallel with graticule lines. This potentiometer can be adjusted with a small screwdriver.

(4).FOCUS

The control knob effects both the trace and the readout sharply.

(5).ILLUM

The knob controls the graticule illumination brightness.

(6).CAL

The terminal provides a reference signal of 2Vp-p at 1kHz for probe adjustment.

Vertical controls

The vertical controls select the displayed signals and control the amplitude characteristics.

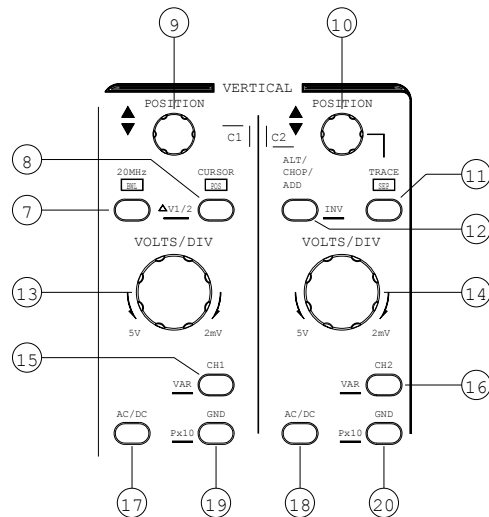
**(7).20MHz BWL – Pushbutton with indicator LED.**

Briefly pressing the pushbutton, the bandwidth is reduced to approx. 20MHz, and the measurement is made by eliminating undesired high frequency signal from the waveform. Also the high frequency component over 20MHz is eliminated from the trigger signal.

(8).CURSOR POS - $\Delta V1/2$ — Pushbutton with double function and associated indicator LED.

The function of Cursor Position or CH1/CH2 Position can be selected only after the pushbutton of Cursor Function is pressed to appear enabling their cursor measurement. Press the pushbutton once briefly to have the related LED lighted, the CH1/CH2 POSITION control knob is then operated as CURSOR 1/CURSOR 2 POSITION control.

 $\Delta V1/2$

The function is required and available only in DUAL mode in combination with ΔV (Voltage) measurement. Pressing and holding the pushbutton, then switch between CH1 and CH2, the measured result will be displayed by the readout with “ $\Delta V1...$ ” or “ $\Delta V2...$ ” providing the deflection coefficient is calibrated. The settings of the cursors must be related to the signal of the selected channel.

(9).CH1 POSITION – C1 — Control knob with double function.

The vertical trace position of channel 1 can be set with the control knob, which is also operated as CURSOR 1 position control in cursor measurement mode.

(10).CH2 POSITION – C2 — Control knob has several functions.

The vertical trace position of channel 2 can be set with the control knob, which is also operated as CURSOR 2 position control in cursor measurement mode. In alternate time base mode, this control knob can be used to separate the DELAY time base trace from the MIAN time base trace. Please note TRACE SEP (11).

(11)TRACE SEP

The instrument contains a trace separate function which is required in the alternate time base mode to separate the DELAY time base trace(s) from the MAIN time base in vertical direction. Consequently this function is only available in alternate time base mode. Press the pushbutton once to have the related LED lighted, the CH1 POSITION control knob is then operated as vertical position control for the trace(s) of the DELAY time base.

(12)ALT/CHOP/ADD-INV

The pushbutton has several functions, which are required and available only when both channels are active.

ALT– Displays in the readout, indicates alternate channel switching.

After each time base sweeps the instrument internally, switches over from channel 1 and channel 2 and vice versa.

CHOP– Indicates chopper mode.

The channel switching occurs constantly between channel 1 and channel 2 during each sweep.

ADD– Displays in the readout, indicates additional mode.

Whether the algebraic sum (addition) or the difference (subtraction) of both input signals is displayed, depends on the phase relationship and the INV setting. As a result, both signals are displayed as one signal. For correct measurements, the deflection coefficients for both channels must be equal.

INV—Pressing and holding the pushbutton to set the channel 2 invert function on or off. The invert on condition is indicated with a horizontal bar above “CH2” in the readout. The invert function causes the signal display of channel 2 to be inverted by 180°.

(13)CH1 VOLTS/DIV.

(14)CH2 VOLTS/DIV– Control knob for channel 1/channel 2 has double function.

Turning the knob clockwise to increase the sensitivity in 1-2-5 sequence and turning it in the opposite direction (CCW) to decrease. The available range is from 2mV/div up to 5V/div. The knob is automatically switched inactive if the related channel is switched off.

The deflection coefficients and additional information regarding the active channels are displayed in the readout.

ie. “CH1=deflection coefficient, input coupling”. The “=” symbolizes calibrated measuring conditions and is replaced by the “>” symbol in uncalibrated conditions.

(15)CH1-VAR.

(16)CH2-VAR — Pushbutton with double function.

CH1/CH2

Pressing briefly the CH1(CH2) button to set the channel 1 (channel 2) of the instrument on, the deflection coefficient will be displayed in the readout indicating the current conditions (“CH1...”/ “CH2...”).

VAR

Pressing and holding the pushbutton to select the VOLTS/DIV function between attenuator and vernier (variable). The current setting is displayed by the “>” symbol in the readout.

After switching on the VAR, turn the VOLTS/DIV control knob counterclockwise to reduce the signal height, and the deflection coefficient becomes uncalibrated.

(17)CH1 AC/DC.**(18)CH2 AC/DC**

Pressing the pushbutton briefly to switch over from AC (~ symbol) to DC (= symbol) input coupling. The setting is displayed in the readout with the deflection coefficient.

(19)CH1 GND– P×10**(20)CH2 GND – P×10** –Pushbutton has two functions.**GND**

Each time when the pushbutton is pressed briefly, the input of the vertical amplifier is grounded. It is displayed in the readout as an earth (ground) symbol “”.

P×10

Pressing and holding the pushbutton to select the indicated deflection coefficient of the channel displayed in the readout between 1:1 and 10:1. The probe factor of 10:1 is displayed in the readout with the probe symbol in front of channel indication (e.g. “P10”, CH1) When proceed cursor voltage measurement, the probe factor will be automatically included. The symbol must not be activated unless a 10:1 attenuator probes are used.

Horizontal controls:

The horizontal controls select the time base operation mode and adjust the horizontal scale, position and magnification of the signal.

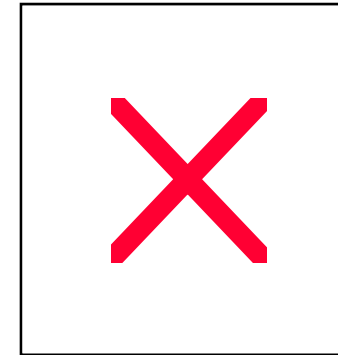
**(21)TIME/DIV–** Control knob with double function.

Turning the knob clockwise to reduce the deflection coefficient in a 1-2-5 sequence and turning it in the opposite direction (CCW) to increase. The time coefficient(s) will be displayed in the readout.

In MAIN time base (MTB) mode, time deflection coefficients between 0.5s/div and 50ns/div can be chosen in 1-2-5 sequence, if the ×10 MAG function is not activated.

During alternate (ALT) and DELAY time base (DTB) operation, the control knob changes the DELAY time base setting in 1-2-5 sequence. The available deflection coefficient range is from 50ms/div up to 50ns/div (without ×10 MAG), but the availability depends on the MAIN time base setting. The internal control of the oscilloscope prevents the DELAY time deflection coefficient from becoming higher than the MAIN deflection coefficient, as such an operation condition would make no sense.

(22)**MAIN/ALT/DELAY—X-Y** – Pushbutton for time base mode selection.

The instrument contains two-time base designated MAIN and DELAY. With the aid of the DELAY time base, signal parts displayed by the MAIN time base can be expanded in X-direction. The expansion ratio depends on the time deflection coefficient ratio of both time bases (ie. “MTB=0.1ms”, “DTB=1 μ s”=100). With higher expansion ratio the DELAY time base trace intensity reduces. Each time when press the pushbutton briefly, the time base mode changes in the sequence of MAIN-ALT-DELAY-MAIN. The actual setting is displayed in the readout.

MAIN

The TIME/DIV control knob is operated only under the MAIN time base mode. The readout then displays the main time coefficient alone. The time base setting for this condition will be stored if the time base mode is changed.

ALT

If the alternate time base mode is selected, the TIME/DIV knob only controls the DELAY time base switch. The alternate time base mode is a sub-function of the DELAY time base mode and both time base traces can be displayed simultaneously. Consequently the readout can display both time deflection coefficient. A window sector which indicates part of signal is also visible on the MAIN trace and is displayed by the DELAY time base.

The window segment can be shifted horizontally by the DELAY TIME control continuously. The difference between the beginning of both the MAIN time base trace and the window sector shows the delay time. The information is also displayed in the readout with an approximate value (e.g. “DLY=0.125ns”) related to the calibrated MAIN time

coefficient (uncalibrated i.e. “DLY>0.125ms”). The width of the window segment decreases when the DELAY time coefficient is set to a lower value (higher time deflection speed).

For better reading, the vertical position of the DELAY time base trace position can be shifted (please note TRACE SEP (11)).

DELAY

In the DELAY time base mode, the display of the MAIN traces, the window sector and the MAIN time coefficient will disappear from the readout. As the trace separation is no longer required under the circumstances, the function would be switched off too. Consequently, only the DELAY time coefficient is displayed by the readout.

X-Y

Switch on or off the X-Y mode by pressing and holding the button. In the X-Y mode, the deflection coefficient is displayed in the readout. The Y axis input is selected by setting the vertical mode pushbutton to the CH1, CH2 and both modes, and the X axis input is selected by setting the TRIGGER SOURCE pushbutton to the CH1, CH2 and EXT.

(23)**H POSITION**

The control knob enables a horizontal position shift of the signals. In combination with $\times 10$ MAG the function makes it possible to shift any part of the signal on the screen.

(24) **$\times 10$ MAG—SETUPS LOCK**— Pushbutton has double function and associated MAG LED.

Each time when this pushbutton is pressed, the MAG LED located above will be switch on or off. If the MAG LED is lighted, the signal display in all time base modes will be expanded 10 folds and consequently only a tenth part of the signal curve is visible. The interesting part of the signal can be made visible with the aid of the H. POSITION control.

SETUPS LOCK

Pressing and holding the pushbutton, then switch the panel setups lock function on or off. To avoid unintentional touch of the setting, the feature is extremely useful for long term and repetitive measurements that need to be performed under the same test condition of the oscilloscope setting.

(25)**AUTO RANGE-VAR** – Pushbutton with double function.

AUTO RANGE

Each time when the pushbutton is pressed briefly the incoming signal is selected, then the time range would change automatically and approx. 1.6 to 4 waveforms are displayed on the screen. If in the $\times 10$ MAG mode, the ten times of waveform of 1.6 to 4 cycles can be displayed.

For signal of 100Hz or in the absence of a trigger, the time range is set to 5ms/div, and for the signals of approx. 8MHz or more, it is set to 50ns/div. The time range change automatically following the different incoming signal.

The AUTO RANGE does not function when the trigger is not obtained. The AUTO RANGE functions with the trigger signal selected by the TRIGGER SOURCE, COUPLING and LEVEL control. The time base mode should be set to MAIN.

In case of measuring a complex waveform such as a TV signal, it may take several seconds to perform the AUTO RANGE function.

VAR

Pressing and holding the pushbutton to select the TIME/DIV (21) control knob function between time base switch and vernier (variable).

The variable function is activated in the MAIN time base only.

After switching on the VAR, the time deflection coefficient is still calibrated until further adjustments are made. Turn the TIME/DIV (21) control knob counter clockwise to increase the time deflection

coefficient (reduce the deflection speed) and the deflection coefficient becomes uncalibrated. Instead of “ $A=10 \mu s$ ”, the readout then displays “ $A>10 \mu s$ ” indicating the uncalibrated condition. This setting is stored if the instrument is switched to ALT or DELAY time base mode. Switch off the VAR by pressing and holding the pushbutton of time base mode again, then set the time deflection coefficient back into the calibrated condition.

Trigger controls

The trigger controls determine the sweep start timing for both signal and dual trace operation.

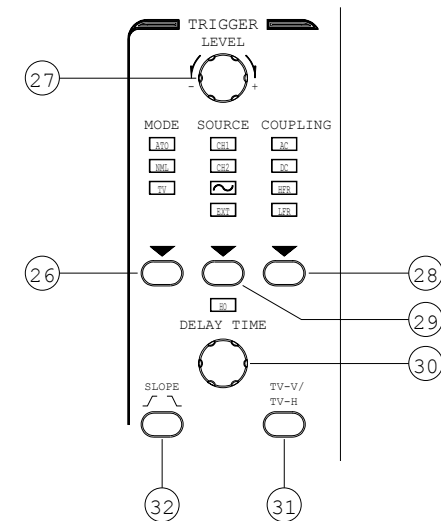

(26)MODE – Pushbutton and indicator LEDs.

Pressing the pushbutton to select the trigger mode. The actual setting is indicated by a LED.

Each time when the MODE pushbutton is pressed the trigger mode changes in the sequence:

ATO—NML—TV—ATO

ATO (Auto)

Select the automatic mode, the sweep free-runs will display a baseline trace when there is no trigger signal or the frequency is below 10Hz. The setting of triggering level changed only when the TRIGGER LEVEL control is adjusted to a new level setting.

NML (Normal)

Select the normal mode, the input signal will trigger the sweep when the TRIGGER LEVEL control is set within the peak-to-peak limits of an adequate trigger signal. When the sweep is not triggered, no baseline trace will be displayed.

TV

Separate the video sync signal from the composite waveform and direct it to the triggering circuit. The horizontal or vertical sync signals are selected by TV-V/TV-H pushbutton. Please refer to the TV-V/TV-H (31).

(27)LEVEL—Control knob

Turning the control knob causes a different trigger input setting (voltage), and set to a suitable position for the starting of triggered sweep of the waveform. An approximate trigger level setting (voltage) value will be displayed in the readout. When rotate clockwise the control knob, the trigger point moves toward the positive peak of the trigger signal and rotate it counterclockwise to move the trigger point toward the negative peak of the trigger signal.

When the setting (voltage) value is out of the changing portion of the observation waveform, the synchronization sweep stops. Sometimes a “?” will be displayed on the left of the valued display, that indicates that direct reading is impossible if AC, HFR, LFR coupling or VAR of vertical deflection is set.

(28)COUPLING –Pushbutton and indicator LEDs.

Pressing the pushbutton to select the trigger coupling. The actual setting is indicated by a LED and by the readout (“source, slope, AC”). Each time when the COUPLING pushbutton is pressed the trigger coupling changes in the sequence:

AC—DC—HFR—LFR

AC

Attenuates trigger signal frequency components below 10Hz and blocks the DC component of the signal.

AC coupling is useful for triggering on AC waveforms that have a large DC offset.

DC

Couples DC and all frequency components of a triggering signal to the trigger circuitry.

DC coupling is useful for most signals, especially for providing a stable display of low-frequency or low-repetition-rate signals.

HFR (High Frequency Reject)

Attenuates high-frequency triggering signal components above 40kHz. HFR coupling is useful for providing a stable display of low-frequency components of complex waveforms and eliminates high-frequency interference from the trigger signal.

LFR (Low Frequency Reject)

Attenuates low-frequency triggering signal components below 40kHz and blocks the DC component of the trigger signal.

LFR coupling is useful for producing stable triggering on the high-frequency components of complex waveforms and rejecting low-frequency interference or power supply hum from the trigger signal.

(29)SOURCE—Pushbutton and associated LEDs.

Pressing the pushbutton to select the trigger signal source or the X signal for an X-Y operation. The actual setting is indicated in a LED and by the readout (“SOURCE”, slope, coupling).

CH1

The signal applied to the channel 1 input connector is the source of the trigger signal.

CH2

The signal applied to the channel 2 input connector is the source of the trigger signal.

 (Line)

The triggering signal is obtained from a sample of the AC power source waveform. The trigger source is useful when the displayed waveform frequency is time related to the AC power source frequency.

EXT

The external signal applied through the EXT input connector is used for the external triggering source signal. When in the dual X-Y operation, the X-axis operates with the external signal.

(30)DELAY-HO—Control knob with a double function and associated LED.

The control knob has two different functions depending on the time base mode.

HO (Hold-off time)

In MAIN time base mode, the control knob applies to the hold off time setting, the HO-LED associated with the knob is dark, the hold off time is set to minimum.

Switch on the LED by turning the control knob clockwise and extend the hold off time until the maximum is reached. An approximate hold off time value will be displayed in the readout (“HO: %”).

The hold off time is automatically set to minimum (LED is dark), if the MAIN time base setting is changed. The hold off time setting is stored and deactivated if ALT (MAIN and DELAY) or DELAY time base mode is selected.

DELAY TIME

In ALT (MAIN and DELAY) and DELAY time mode, the knob controls the delay time setting.

Under the ALT time base mode, the delay time is visible on the main trace, beginning at the trace start and ending at the start of the window sector. An approximate delay time value will be displayed in the readout (“DLY=”).

If only select DELAY time base, the delay time can also be varied, but there would be no window sector as the main trace is not visible.

(31) **TV-V/TV-H**—Pushbutton for video sync signal selection.

TV-V

Start the main trace at the beginning of a video signal field. SLOPE polarity must match the composite sync polarity (i.e., “-” for negative sync) to obtain TV field triggering on the vertical sync pulse.

TV-H

Start the main trace at the beginning of a video signal line. SLOPE polarity must match the composite sync polarity to obtain TV line triggering on the horizontal sync pulse.

The current setting is displayed in the readout under item “source, video polarity, TV-H”.

(32) **SLOPE** (\lrcorner \llcorner)—Pushbutton for the triggering slope or video polarity selection.

If in the AUTO or NML trigger mode, briefly pressing the pushbutton to select the slope of the signal which is used for triggering the time base generator. Each time when the pushbutton is briefly pressed, the slope direction will switch from falling edge to rising edge, and vice versa.

The current setting is displayed in the readout under item “source, SLOPE, coupling”.

If in the TV trigger mode, briefly pressing the pushbutton to select the video polarity, which will be displayed in the readout with a “+” symbol of positive video signal and a “-” symbol of negative video signal.

Measurement and Panel setting Control

The measurement section controls the on-screen readout and the cursor measurements. For more information, please refer to page 9 “PANEL INTRODUCTION” section for the instrument to store and recall the panel setting.



(33) **CURSOR FUNCTION-ON/OFF**—Pushbutton with two functions.

ON/OFF

Pressing and holding either pushbutton to switch both cursor lines on or off. As the cursor lines are part of the readout, they are visible only when the readout is switched on.

CURSOR FUNCTION

Each time when the pushbutton is briefly pressed the seven measurement functions will be selected in the sequence as below:

ΔV	:	Voltage difference measurement.
$\Delta V\%$:	Voltage difference percentage measurement (5div=100% reference)
ΔVdB	:	Voltage gain measurement. (5div=odB reference, $\Delta VdB=20 \log, \text{div}/5\text{div}$).
ΔT	:	Time difference measurement.
$1/\Delta T$:	Frequency measurement.
$\Delta T\%$:	Time difference percentage measurement. (5div=100% reference).
$\Delta \theta$:	Phase measurement. (5div=350° reference).

(34) ◀ MEMO-9 ▶ —SAVE/RECALL

The instrument contains 10 non-volatile memories, which can be used by the operator to save instrument setting and to recall them. It relates to all controls which are electronically selected.

Press ◀ o ▶ pushbutton to select the memory location. The readout then indicates the letter “MEN” followed by a cipher between 0 and 9. Each time the pushbutton is briefly pressed the memory location cipher increases until the number 9 is reached. The pushbutton is similar but decreases the memory location cipher until the number 0 is reached. Pressing and holding SAVE for approx. 3 seconds to write the instrument settings in the memory and indicate the associated readout information of “SAVED”.

To recall a front panel setup, select a memory location as described above. Recall the settings by pressing and holding the RECALL pushbutton for approx. 3 seconds, the readout then indicates the associated readout information of “RECALLED”.

Input connectors

The input section is where the input signals are commonly connected to the oscilloscope.

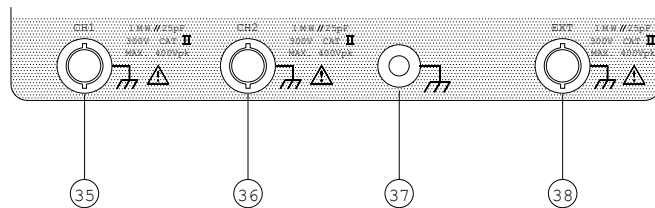

(35) CH1—Input BNC socket

This BNC socket is the signal input for channel 1. In X-Y mode, signals at this input are used for the Y or X deflection. The outer (ground) connection is galvanically connected to the instrument ground and consequently to the safety earth contact of the line/mains plug.

(36) CH2—Input BNC socket

This BNC socket is the signal input for channel 2. In X-Y mode, signals at this input are used for the X or Y deflection. The outer (ground) connection is galvanically connected to the instrument ground and consequently to the safety earth contact of the line/mains plug.

(37) Ground socket—Banana Socket galvanically connected to safety earth.

This socket can be used a reference potential connection for DC and low frequency signal measurement purposes.

(38) EXT—This BNC socket is the external trigger signal input.

In dual X-Y mode, signals at this input are used for the X deflection. Pressing the TRIG. SOURCE (29) pushbutton until the information of “EXT, slope, coupling” is shown up in the readout and the TRIG. SOURCE “EXT” LED is lighted, switches the input on.

The outer (ground) connection is galvanically connected to the instrument ground and consequently to the safety earth contact of the line/mains plug.

The maximum input voltages of the instrument input terminals and probe input terminals are listed in the section of 3-6. Withstanding voltage of Input terminals”. Do not apply voltage higher than the limit.

4-2.Rear Panel

The rear panel provides input power and additional signal connections.

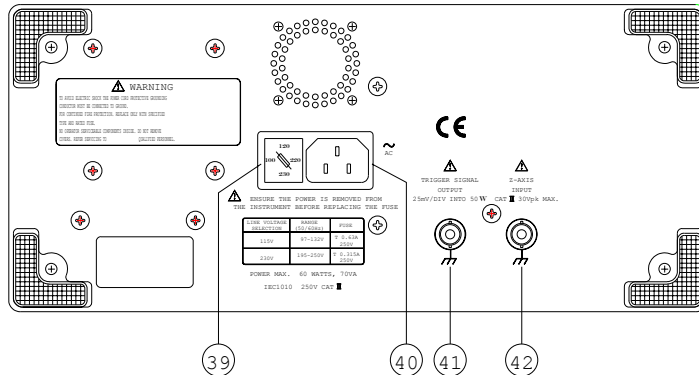

(39)**Line voltage selector and input fuse holder**—Select power source and contain the primary power fuse

The fuse rating is shown in the section of 3-2 Checking the line voltage.

(40)**AC power input connector**

Connect the AC power cord to the power supply of instrument, the power cord protective-ground connection is connected to the exposed metal part of the instrument. The power cord must be connected to a proper grounded source for electrical-shock protection.

(41)**TRIGGER SIGNAL Output**—BNC socket

The signal selected by the TRIG. SOURCE (29) is available. This output may be used to connect to a frequency counter or other instrument.

(42)**Z-Axis Input**—BNC socket

Connect external signals to the Z-axis amplifier for intensity modulating the CRT display. This terminal is DC-coupled. The intensity is lowered by a positive signal, while it is increased by a negative signal.

5. OPERATION METHOD

This section contains basic operation information and techniques that should be considered before proceeding any measurement. As for the location and function of instrument controls, connectors, and indicators, refer to the "Instruction of Front Panel and Rear Panel" of this manual.

5-1. Readout Display

The CRT readout display indicates how to set up the instrument controls. No physical marking shown on the rotating switches indicates the control setting. A key to the location and type of readout information displayed is illustrated in figure 5-1:

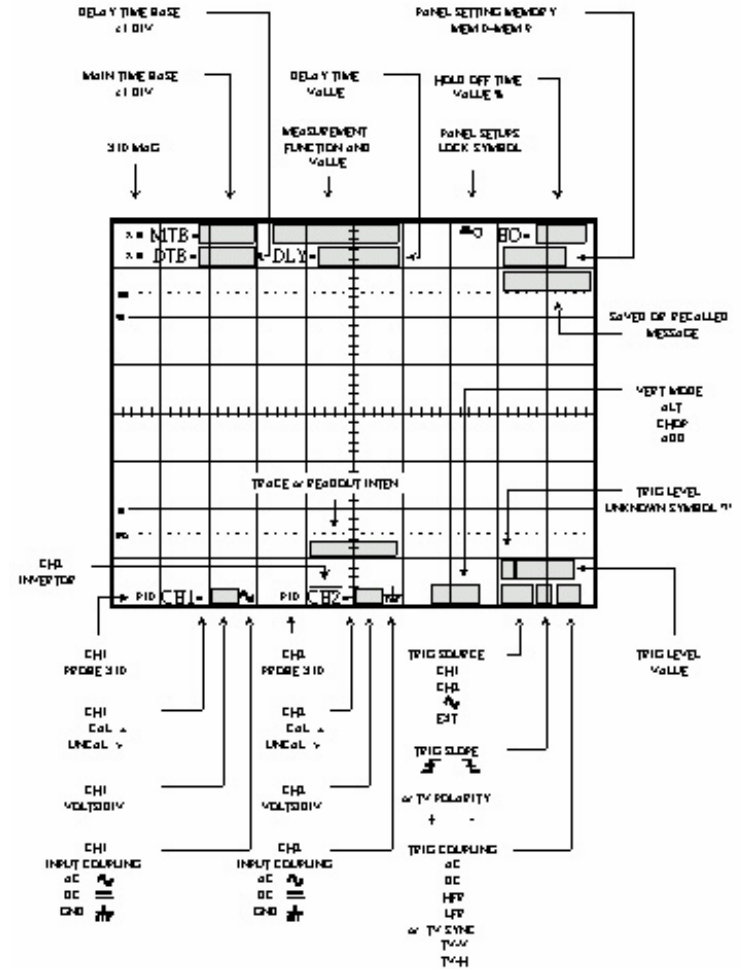

Figure 5-1

5-2.Connecting Input Signals

Grounding

The most reliable signal measurements are made when the oscilloscope and the unit under test are connected by a common reference (ground lead) in addition to the signal lead or probe. The ground lead of the probe provides the best grounding method for signal interconnection and ensures the maximum amount of signal-lead shielding in the probe cable. A separate ground lead (with a banana plug) can also be connected from the unit under test to the oscilloscope ground jack on the front panel.

Probes

A probe provides the most convenient way to connect an input signal to the oscilloscope. The standard $\times 1/\times 10$ probes supplied to the oscilloscope are shielded against electromagnetic interference and have a high input impedance for low circuit loading.



CAUTION. To get the best waveform precisely, keep probe ground and signal leads as short as possible.

Misadjust probe compensation can cause measurement error. Check and adjust probe compensation whenever a probe is moved to a different channel or oscilloscope. As for the probe compensation adjustment procedure, refer to the "Probe Compensation".

Coaxial Cables

Signal input cable can greatly affect the accuracy of a displayed waveform. To maintain original frequency characteristics of the input signal, use only high-quality, low-loss coaxial cables. Coaxial cables must be terminated at both ends in their characteristic impedance to prevent signal reflections within the cable. Use suitable impedance-matching devices.

5-3.Adjustments and checks

Trace Rotation Adjustment

Normally, when the trace is in parallel with the center horizontal graticule line, there will be no need to adjust the TRACE ROTATION. If necessary, adjust the TRACE ROTATION to make the baseline trace parallel to the center horizontal graticule line by using a small straight-blade screwdriver or alignment tool.

Probe Compensation

To minimize the distortion of measured waveforms, check the compensation of your probes before using them. The probe compensation should be checked periodically whenever the probes are moved to different input channels.

1. Install the probes onto the oscilloscope (Press the BNC connector onto the channel input and rotate the connector to lock it into place).
2. Set the probe slide switches to the $\times 10$ position.
3. Briefly pressing the CH1/CH2 button to set the oscilloscope to channel 1 and channel 2.
4. Pressing and holding the P $\times 10$ button to set the indicated deflection coefficient of the channel displayed in the readout as a symbol "P10".
5. Attach the probe tips to the CAL connection in the front of the oscilloscope.
6. Set the oscilloscope controls to display both channels:

VERTICAL:	VOLTS/DIV	1V
	COUPLING	DC
	ALT/CHOP/ADD	CHOP
HORIZONTAL:	MODE	MTB
	TIME/DIV	0.5ms
TRIGGER:	MODE	ATO
	SOURCE	CH1 or CH2
	COUPLING	AC
	SLOPE	

7. Observe the displayed waveform and compare them with the waveforms shown in figure 5-2. If either probe needs to be adjusted, proceed the step 8. If either probe does not need to be adjusted, proceed the "Function Check".

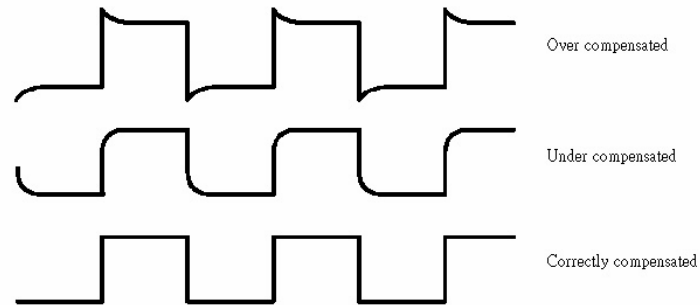

Figure 5-2 Typical Compensation Waveform

8. Adjust the probe by using a small insulated screwdriver. Slowly rotate the adjustment control until the probe is properly compensated.

5-4. Function Check

When you start to check the operation of your oscilloscope, proceed the following instruction:

1. Install the $\times 10$ probes onto CH1 and CH2 inputs.
2. Connect the probe tips to the CAL test point of the oscilloscope.
3. Set the oscilloscope controls to display both channels:

VERTICAL:	VOLTS/DIV	1V
	COUPLING	DC
	ALT/CHOP/ADD	CHOP
HORIZONTAL:	MODE	MTB
	TIME/DIV	0.5ms
TRIGGER:	MODE	ATO
	SOURCE	CH1 or CH2
	COUPLING	AC
	SLOP	\perp

The figure 5-3 below illustrates a satisfactory display. The waveform should be approximately 2Vp-p at a frequency of 1kHz that confirms the vertical and horizontal deflection function of the oscilloscope.

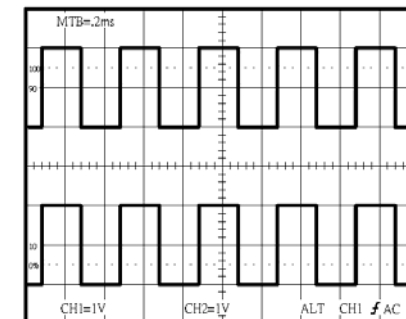

Figure 5-3 Display 1

4. Set both CH1 and CH2 COUPLING to GND.
5. Use the CH1 and CH2 POSITION controls to align both traces on the center graticule.
6. Open the CH2 INV by pressing and holding the pushbutton.
7. Set to the ADD mode by pressing the ALT/CHOP/ADD pushbutton briefly.
8. Set both CH1 and CH2 COUPLING to DC.
9. The figure 5-4 below shows a satisfactory display. The display will show a flat trace located on the center graticule that confirms the channel balance and ADD offset function.

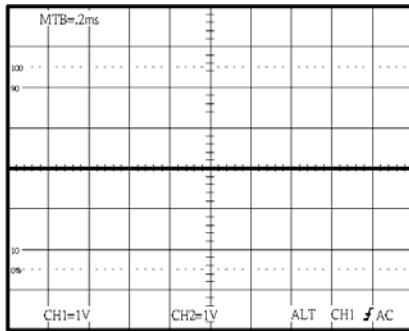

Figure 5-4 Display 2

10. Set to the CHOP mode by pressing the ALT/CHOP/ADD pushbutton briefly.
11. Turn off the CH2 INV by pressing and holding the pushbutton.

5-5. Basic Operation

Displaying CH1 or CH2

To display the signal from a signal channel, pressing briefly the CH1 or CH2 pushbutton to set the oscilloscope to channel 1 or channel 2.

Displaying CH1 and CH2

To display both signals at the same time, proceed the following steps:

1. Set the CH1 and CH2 on. The figure 5-5 below shows two synchronous waveforms in the both modes.
2. Adjust the CH1 or CH2 POSITION control to position the two waveforms.
3. Set the ALT/CHOP/ADD button to CHOP mode if the waveforms are flickering.

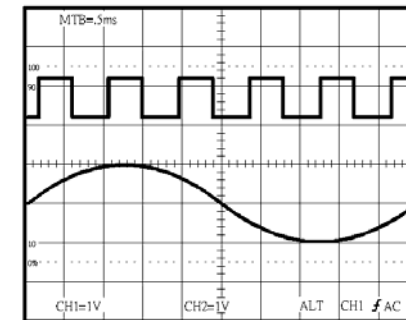

Figure 5-5 Both typical waveforms

Displaying the sum or difference of CH1 and CH2

To display the algebraic sum or difference of CH1 and CH2, proceed the following steps:

1. Set the ALT/CHOP/ADD button to ADD mode. The figure 5-6 below shows the sum of the waveforms from figure 5-5.
2. Set the CH2 INV on by pressing and holding the button, if necessary, to display the different waveform.
3. Pressing and holding one of the VAR buttons to set the VOLT/DIV control knob to vernier (variable). Then adjust one channel to the other in the event of gain difference.

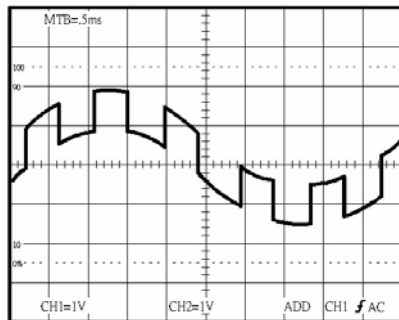

Figure 5-6 Typical ADD waveform

Comparing Frequency and phase (Single X-Y Operation)

To compare the frequency and phase between two signals by using the X-Y mode. The X-Y waveform displays different amplitude, frequency, and phase. The figure 5-7 shows a typical waveform made up of two signals that are of the same frequency and amplitude, but approximate 45° out of phase.

To use the oscilloscope in the signal of X-Y mode, proceed the following steps:

1. Connect the horizontal or X-axis signal to the CH1 input.
2. Connect the vertical or Y-axis signal to the CH2 input.
3. Set the CH1 off, and set the CH2 on.
4. Set the X-Y mode on by pressing and holding the button.
5. Set the TRIG SOURCE button to CH1.

Use the HORIZONTAL POSITION control to adjust the X-axis.

Note: When high frequency signals are displayed in the X-Y operation, note the frequency bandwidths and phase difference between X and Y axis. Refer to “2. SPECIFICATION” section for details.

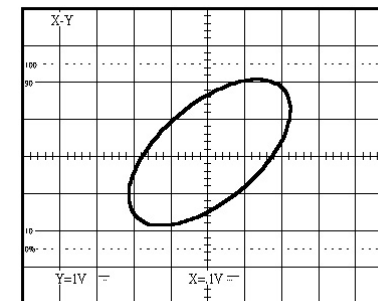

Figure 5-7 Typical single X-Y display.

Setting up Dual X-Y Operation

To use the oscilloscope in the dual X-Y mode, proceed the following steps:

1. Connect the horizontal or X-axis signal to the EXT (X) input.
2. Connect one of the vertical or Y-axis signal to the CH1 (Y1) input.
3. Connect either of the vertical or Y-axis signal to the CH2 (Y2) input.
4. Set the CH1 and CH2 on.
5. Set the ALT/CHOP/ADD button to CHOP mode.
6. Set the X-Y mode on by pressing and holding the button.

The figure 5-8 shows two X-Y waveforms in the dual X-Y mode.

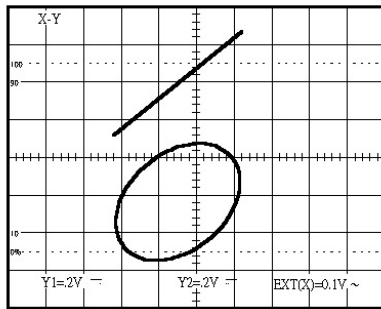

Figure 5-8 Typical dual X-Y display

Setting Up delayed-sweep Operation

A delayed sweep is used to magnify any portion of a complex waveform in the horizontal direction.

To display the delayed sweep operation, proceed the following steps:

1. Briefly pressing the MAIN/ALT/DELAY pushbutton to set to MAIN time base of the horizontal mode. Effect triggering by main sweep and set MAIN TIME/DIV control as desired.

2. Set the MAIN/ALT/DELAY button to ALT mode, and set the time range of the DELAY TIME/DIVE control to be magnified.

The figure 5-9 below shows the main and delayed sweeps appear simultaneously on the screen, and the window sector will appear.

3. Adjust the DELAY TIME control to move continuously the window sector. Bring the window sector to the position to be magnified. Then, the waveform between the window sector is magnified to occupy the full area of the screen.

4. If necessary, press the TRACE SEP pushbutton to set the LED on. The

delayed sweep trace can be shifted vertically about ± 3 divisions with respect to the main sweep trace for the convenience of observation by the POSITION control.

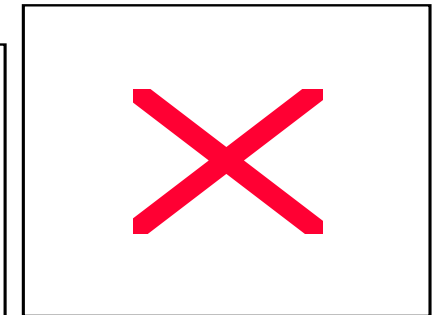
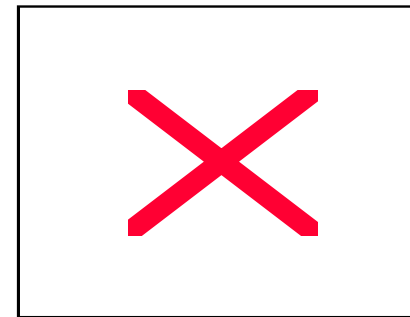

Figure 5-9 ALT Mode

Figure

5. Set the DELAY mode to measure the magnified waveform only by pressing the MAIN/ALT/DELAY button. The magnified waveform shown in figure 5-10.

Magnifying Waveform Events

Use the $\times 10$ MAG pushbutton to view small portions of a waveform as which is too far back from the starting point to view by using the TIME/DIV control. To use the $\times 10$ MAG button, proceed the following steps:

1. Adjust the TIME/DIV to the fastest sweep that displays the event.
2. Rotate the HORIZONTAL POSITION control to move the event to display on the center of screen.
3. Press the $\times 10$ MAG button to switch the MAG LED on.

When above procedures have been done, the displayed waveform will be expanded 10 times to the right and left from the center of screen as center of expansion.

Operating HO (Hold off time) Control

When the measured signal is a complex waveform with two or more repetition frequencies (period), triggering with the LEVEL control alone may not be sufficient to attain a stable waveform display. In such a case, the sweep can be stable synchronized to the measured signal waveform by adjusting the HO (Hold off) time of the sweep waveform.

Figure 5-11(a) shows several different waveforms which overlapped on the screen, marking the signal observation unsuccessful when the hold off is set to minimum (the HO-LED is dark).

Figure 5-11(b) shows the undesirable portion of the signal is held off. The same waveforms are displayed on the screen without overlapping.

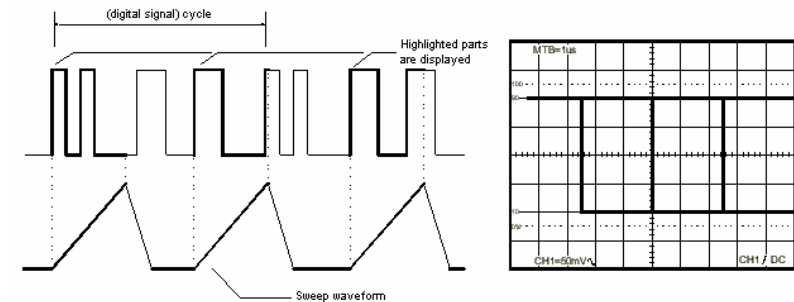

Figure 5-11(a)

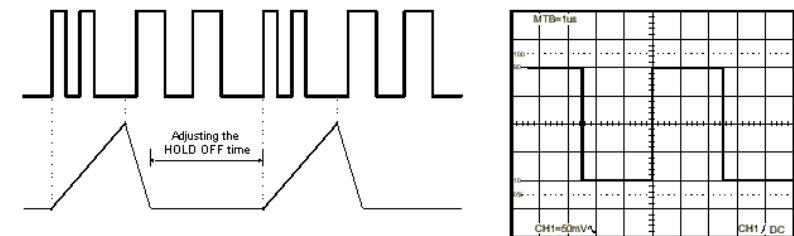

Figure 5-11(b)

Triggering of Video signal

In the work concerned with TV, complex signals and containing video signal, blanking pedestal signal, and synchronizing signal are often measured.

Press the TRIG MODE pushbutton to set the TV position. The built-in active TV-Sync-separator provides the separation of frame or line sync pulses from the video signal. To trigger the oscilloscope at the vertical (frame) rate, press the TV-V/TV-H pushbutton to set TV-V coupling. To trigger the oscilloscope at the horizontal (line), press the TV-V/TV-H pushbutton to set TV-H coupling. The figure 5-12(a) shows vertical signal of TV-V and Figure 5-12(b) shows horizontal signal of TV-H.

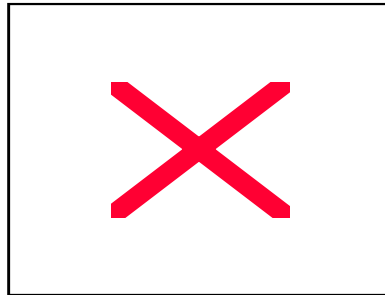

Figure 5-12(a) TV-V

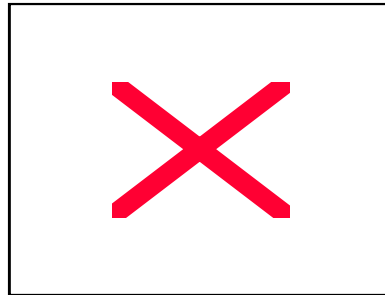

Figure 5-12(b) TV-H

The polarity of the synchronization pulse is critical for the slope selection. The figure 5-13(a) and 5-13(b) shows the examples of TV polarity synchronization signals.

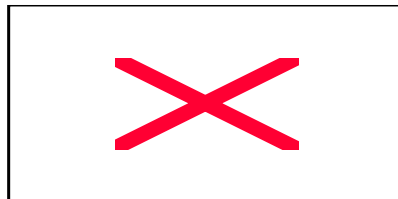

Figure 5-13(a) (-) Sync signal.

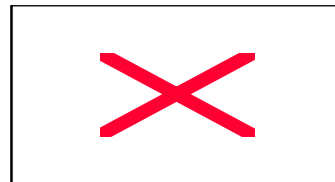

Figure 5-13(b) (+) Sync signal

5-6.Measurement Application

The oscilloscope has a cursor measurement system for making accurate, direct-readout voltage, time, frequency and phase measurements. The measurements described in this section are examples of typical applications using this measurement system. After becoming familiar with the controls, indicators, and capabilities of the instrument, you can develop convenient methods to make the special measurement for your own applications.

Proceed a measurement by using the cursor according to the following steps:

1. Pressing and holding the CURSOR FUNCTION-ON/OFF pushbutton to turn on the cursor and measurement readout.
2. Briefly pressing the pushbutton to select the seven measurement function in the sequence as below:

$\Delta V - \Delta V\% - \Delta VdB - \Delta T - 1/\Delta T - \Delta T\% - \Delta \Theta - \Delta V$

3. If the associated indicator CURSOR POS-LED is lighted, rotate the C1-POSITION control to position the cursor 1 and rotate the C2-POSITION control to position the cursor 2.
4. Read the measurement value on the screen. Typical measurement readouts and applications are shown in Figure 5-14. The measurement values are automatically controlled by the VOLTS/DIV and TIME/DIV control settings.

Figure 5-14: Cursor Measurement

(a). Typical ΔV (Voltage difference) for AC voltage.

When both CH1 and CH2 are turned on, the measurement value of CH1 ($\Delta V1$) or CH2 ($\Delta V2$) can be displayed by pressing and holding the $\Delta V1/2$ pushbutton.

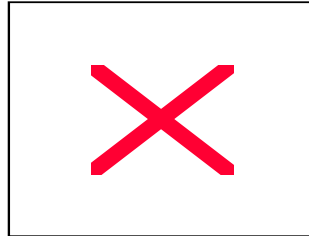

(b). Typical $\Delta V\%$ (Voltage percentage) cursor measurement for overshoot of square waveform.

A voltage percentage measurement is done by first setting a reference for the full scale (amplitude) waveform: 5div=100%.

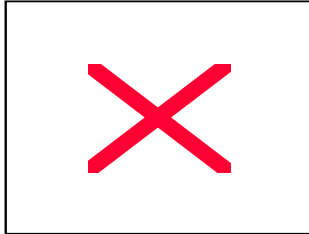

(c). Typical ΔV_{dB} (voltage gain) cursor measurement for -3dB bandwidth application.

The percentage reference is: 5div=0db.

The measurement values calculate the voltage gain from the formula:

$$\Delta V_{dB} = 20 \log(\Delta V_{div}/5div)$$

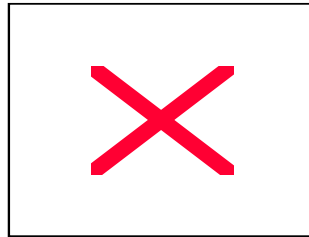

(d). Typical ΔT (Time difference) cursor measurement for rise time.

Proceed rise-time or fall-time measurement requiring some additional signal scaling by using the graticule rise-time measurement aids. Number 0%, 10, 90 and 100 are etched near the left vertical gratical line. Use the following steps as a guideline to in making rise-time measurement:

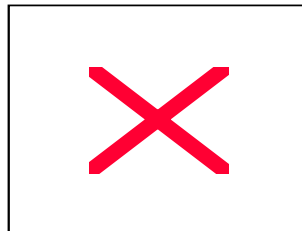

1. Set the VOLTS/DIV and VAR controls to provide an exact five-division vertical display.
2. Use the vertical POSITION control to control the negative amplitude of the signal on the 0% reference line and the positive amplitude on the 100% reference line.
3. Increase the TIME/DIV setting to stretch out the rising edge of the waveform as much as possible to improve the cursor placement accuracy.
4. Use the C1-POSITION control to align the cursor 1 to the rising edge at the point where it crosses the 10% reference graticule line. Then use the C2-POISITION control to align the cursor 2 to the point where the rising edge crosses the 90% graticule line and read the rise time displayed in the CRT readout.

(e). Typical $1/\Delta T$ cursor function for frequency measurement.

When the two cursors are superimposed at two edge points of the one period waveform by the C1-POSITION and C2-POSITION controls, the measurement value is displayed in frequency units on the upper side of the screen.

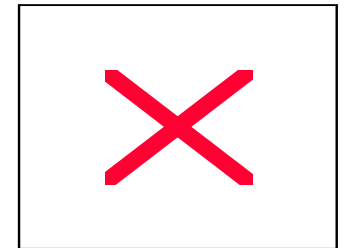

(f). Typical $\Delta T\%$ (Time difference percentage) cursor function for duty-cycle measurement of square waveform.

A time difference percentage measurement is done by first setting a reference for the full cycle of waveform period: 5div=100%.

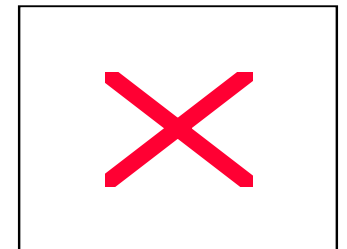

(g). Typical $\Delta \Theta$ cursor function for phase measurement.

A phase measurement is done by first setting a reference for the full 360° waveform period:

5div- 360° .

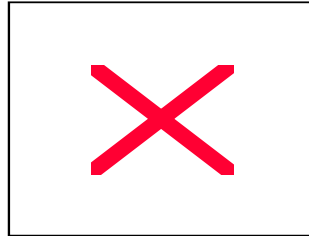

NOTE. When the VOLTS/DIV or the TIME/DIV controls are in uncalibrated setting, the ΔV and ΔT measurement values will be displayed with divisions.

When the vertical mode is set to the ADD mode, and the CH1 and CH2 VOLTS/DIV controls are set to different scales, the ΔV measurement values will be displayed with divisions.

6. MAINTENANCE

The following instructions are executed by qualified personnel only. To avoid electrical shock, do not perform any servicing other than the operating instructions unless you are qualified to do so.

6-1. Fuse Replacement

If the fuse blows, the power lamp indicators will not light and the oscilloscope will not start. The fuse should not normally open unless a problem has developed in the unit. Try to determine and correct the cause of the blown fuse and replace only with a fuse of the correct rating and type on the rear panel.



WARNING. For continued fire protection. Replace fuse only with 250V fuse of the specified type and rating, and disconnect power cord before replacing fuse.

6-2. Line Voltage Conversion

The primary winding of the power transformer is tapped to permit operation from 115, or 230VAC 50/60Hz line voltage. Conversion from one line voltage to another is done by changing the line voltage selector switch as shown in page 7. The rear panel identifies the line voltage to which the unit was factory set. To convert to a different line voltage, perform the following procedure:

- (1). Make sure the power cord is unplugged.
- (2). Adjust the line voltage selector switch to the desired line voltage position.
- (3). A change in line voltage may also require a corresponding change of fuse value. Install the correct fuse value as listed on rear panel.

6-3.Cleaning

To clean the oscilloscope, use a soft cloth dampened in a solution of mild detergent and water. Do not spray cleaner directly onto the oscilloscope because it may leak into the cabinet and cause damage.

Do not use chemicals containing benzine, benzene, toluene, xylene, acetone, or similar solvents. Do not use abrasive cleaners on any portion of the oscilloscope.

7.Block Diagram